



HOME CARE BED SOLUTIONS

Beds, Accessories and Information



Rest Assured, Medline Cares About Patients and Your Business.



Table of Contents

MedLite Beds

Full-Electric Bed	6-7
Semi-Electric Bed	6-7
Full-Electric Low Bed.	8

Basic Beds

Full-Electric Bed	10-11
Semi-Electric Bed	10-11

Bariatric Beds

Full-Electric Bariatric Bed.	14
Adjustable-Width Bariatric Bed	15
Low-Height Bariatric Bed.	15
Extra-Weight Capacity Bariatric Bed	16

Accessories

MedLite and Basic Bed Accessories	18
Mattresses	18
Side Rails	19
Trapeze Bars.	20
Overbed Tables.	21
Hydraulic Lifts	22
Stand Assists	22
Slings	23

Articles

Growing Number of Injuries Among Delivery Drivers.	4
Expanded Competitive Bidding Program . . .	12



The Medline Guarantee

We guarantee everything we sell. Our products are built to last, as evidenced by our generous warranty. Should you have an issue with a Medline product, please call us or speak to your Medline sales representative and we will resolve the issue quickly and efficiently.



**MedLite
Beds**



**Basic and
Bariatric Beds**



Value, at Every Stage

Dear Customers, Dealers and Distributors:

As president of Medline's Durable Medical Equipment (DME) division, I'm proud of our complete selection of home care beds and accessories. Throughout this brochure, you'll find high-quality home care beds and accessories, along with helpful information on topics affecting our industry.

At Medline, we will always go the extra mile to ensure your complete satisfaction.

Sincerely,

Rich Derks

Rich Derks
President, DME Division
Medline Industries, Inc.

High-Quality Beds

Medline beds meet or exceed very stringent dynamic and static load requirements. Each bed is inspected and fully system tested at maximum weight capacity.

Overall Cost Effectiveness

As National Competitive Bidding (NCB) moves forward, reimbursements are being slashed by up to 30 percent.¹ To offset these reductions, it's more important than ever to find new ways to cut costs:

- **Reduced overall cost of ownership** – Because Medline beds stand the test of time, we offer some of the longest warranties in the industry.
- **Reduced risks** – Medline has beds and motors that are very light, reducing the risk of back injuries or property damage during storage, setup and transport.
- **Economical beds for rentals that you expect to cap out** – Our Basic beds offer a lower price-point to help reduce your up-front costs, and they still come with a generous two-year warranty.
- **Increased efficiency** – The electronics on Medline's MedLite beds are washable, so cleaning doesn't require removal of the motor. And with our wide selection, you can get everything you need, without having to shop around.

Reliable Service

Medline has a large staff of friendly and knowledgeable home care bed specialists, sales representatives and customer service agents who are waiting to provide you with world-class support.



Reference:

1. Medicare to Save Taxpayers And Beneficiaries \$28 Billion With an Expanded Competitive Bidding Program. Centers for Medicare and Medicaid Services.

<http://www.cms.gov/apps/media/press/release.asp?Counter=4064&intNumPerPage=10&checkDate=&checkKey=2&srchType=2&numDays=0&srchOpt=0&srchData=competitive+bitding&keywordType=All&chkNewsType=1%2C+2%2C+3%2C+4%2C+5&intPage=&showAll=1&pYea.> Accessed 10/5/2011.

Growing Number of Injuries Among Delivery Drivers

US DEPARTMENT OF LABOR STATISTICS ON OCCUPATIONAL INJURIES

Increase of 24 percent for light or delivery service truck drivers!



KEY FINDINGS:

Despite the total decrease in the incidence rate, the following occupations in the private sector had increases in their rates:

- Light or delivery service truck drivers **(increased 24 percent)**
- Restaurant cooks (increased 20 percent)
- Landscapers and grounds-keepers (increased 10 percent)
- Registered nurses (increased 5 percent)

The number of reported nonfatal occupational injury and illness cases that require days away from work to recuperate decreased by 9 percent recently for private industry, state government and local government, according to the Bureau of Labor Statistics. The total incidence rate decreased 5 percent to 117 cases per 10,000 full-time workers. Some of the overall decrease in case counts may be attributed to economic factors, including a decrease in employment and total hours worked, particularly in construction and manufacturing.

CASE CHARACTERISTICS

Overexertion accounted for 22 percent of all occupational injuries and illnesses. Among the seven occupations with high case counts and incidence rates, it was the leading event or exposure for nursing aides, orderlies and attendants; janitors and cleaners; and all truck drivers (except driver/sales workers).

Table A

Percent of Total Musculoskeletal Disorders by Selected Body Part

Occupation	Total	Shoulder	Back	Abdomen	Arm	Wrist	Leg	Multiple Body Parts
Truck drivers, light or delivery services	100	12.6	47.6	5.2	3.7	1.4	14.3	4.7

Table B

Nonfatal Occupational Injuries and Illnesses Involving Days Away from Work

Occupation	Number	Median days away from work
Truck drivers, light or delivery services	31,600	14

The study also showed that with truck drivers, light or delivery services, there was a median of 14 days away from work as a result of these injuries.

With statistics like these, HME dealers can't afford to take delivery drivers' backs for granted.

Adapted from Nonfatal Occupational Injuries and Illnesses Requiring Days Away From Work. Available at http://www.bls.gov/news.release/archives/osh2_11092010.pdf. Accessed September 30, 2011.

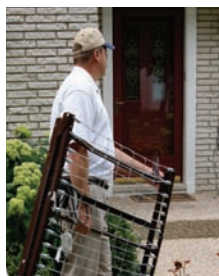

DID YOU KNOW...?

Medline's MedLite beds are up to 40 lbs. lighter than most other home care bed available today, helping you reduce the risk of injuries to your delivery drivers.



MedLite Beds

Exceptionally light and easy to use.



The lightest beds with a great warranty! MedLite beds help reduce the risk of back injuries or property damage because they are among the lightest home care beds in the industry.

Above shown with MedLite bed MDR107003L, mattress MDR230981, side rail MDS89697, and overbed table MDS104015.

MedLite Beds are:

High-Quality

- Premium Linak® motors provide smooth reliable operation for years
- Recessed headspring supports and foot assembly reduce the chance of pinching and injuries

Light

- We have some of the industry's lightest beds, making transport, setup and storage much easier
- Our MedLite semi-electric bed weighs only 137 lbs (62 kgs)
- The 24V DC motors are also lightweight – and quiet

Strong

- An extra steel plate is welded to the middle of the frame ensuring strong and stable support
- Painted frames have three coats of enamel plus a clear coat for a strong, chip and scratch-resistant finish
- Durable plastic woodgrain end panels resist breakage
- Heavy-duty remotes resist breakage and moisture

Easy-To-Use

- The beds can be cleaned without having to remove the motor, and the electronics can be washed down with standard water pressure
- End panels are easy to wipe down and keep clean
- Smooth rolling, casters make the bed easy to move
- Convertible to a low bed using Med= Low Bed Conversion Kit – sold separately (see page 8)

MedLite Full-Electric Bed



MedLite Semi-Electric Bed

Among the lightest home care beds in the industry!



- ▶ Premium, quiet Linak motors provide dynamic movement without disturbing other family members
- ▶ Heavy-duty remote control
- ▶ Recessed headspring and foot assembly supports reduce the chance of pinching and injuries
- ▶ One of the longest warranties in the industry

Specifications

Assembled weight	145 lbs. (66 kg)
Height range	14.5" - 22.5" (37–57 cm)
Weight capacity	450 lbs. (204 kg)
Casters	Four (2 locking) 3" (8 cm)
Warranty	5 years for electrical and mechanical components; lifetime for the bed frame

Item No.	Description
MDR107003L	Full Electric Bed

"My dealership prefers Medline beds because they're a good value for the money. They're very durable and the long warranty gives us peace of mind. Thanks Medline!"

*Frank Lopez, AV Pulmonary Care,
Lancaster, CA*

- ▶ Features both automation and a traditional hand crank
- ▶ Premium, quiet Linak motors provide dynamic movement without disturbing other family members
- ▶ Weighs only 137 lbs (62 kg), one of the lightest beds in the industry
- ▶ Easy to clean without the need to remove the motor

Specifications

Assembled weight	137 lbs. (62 kg)
Height range	14.5" - 22.5" (37 –57 cm)
Weight capacity	450 lbs. (204 kg)
Casters	Four (2 locking) 3" (8 cm)
Warranty	5 years for electrical and mechanical components; lifetime for the bed frame

Item No.	Description
MDR107002L	Semi-Electric Bed

Standard on all Medline beds, the heavy-duty remote control resists breakage and moisture



MedLite Full-Electric Low Bed

Help reduce falling injuries!
This bed can be lowered
to 9.5" (24 cm) off the floor.



Only 9.5"
from floor to
bed deck in
lowest position!



- ▶ Low height helps minimize the possibility of injuries for patients who are at risk of falling out of bed
- ▶ Premium, quiet Linak motors provide dynamic movement without disturbing other family members
- ▶ Recessed headspring supports and foot assembly reduce the chance of pinching and injuries
- ▶ An extra steel plate is welded to the middle of the frame ensuring strong and stable support

Specifications

Height range	9.5"-22.5" (24-57 cm)
Assembled weight	145 lbs. (66 kg)
Weight capacity	450 lbs. (204 kg)
Casters	Four casters (2 locking)
Warranty	5 years for electrical and mechanical components; lifetime for the bed frame

Item No.	Description
MDR107003LO	Full-Electric Bed with Low-Rise Feature



Convert your Full Electric MedLite bed into the MedLite Low bed!

- Easy installation – no tools needed!

Item No.	Description
MDSLOWBED	MedLite Low Bed Accessory Kit



Basic Beds

Comfort and reliability
at an economical price.



Basic beds offer a lower price-point to help reduce your up-front costs. With Medline Basic beds, you have an incomparable combination of value and quality.

*Above shown with Basic bed
MDR107002E, mattress MDR237827,
side rail MDS89690, and overbed
table MDS107015*

Basic Beds are:

Light

- Easy to transport with a foot section that weighs just 42 lbs (19 kgs)

Easy-To-Use

- Convenient DC motor box snaps off quickly, making delivery, setup, and routine maintenance easier

Safe

- A 9V battery back up allows movement to lowest bed position during power failures (batteries not included)
- Headspring supports recessed to resist pinching and injuries
- Foot assembly recessed to reduce chance of pinching

High Quality

- 2-Year Warranty on electronics and mechanical components
- 100% system tested and certified

Basic Full-Electric Bed

Provides high reliability at an economical price



Basic Semi-Electric Bed

Features both a smooth high-low motor and a traditional hand crank



- ▶ Light weight – foot section weighs just 42 lbs. (19 kg)
- ▶ Convenient DC motor box snaps off quickly, making delivery, setup, and routine maintenance much easier
- ▶ 9V battery backup allows lowering during power failures (battery not included)
- ▶ Recessed headspring supports and foot assembly help reduce the chance of pinching and injuries

Specifications

Height range	15" - 20" (38 cm - 51 cm)
Bed deck dimensions	80" (203 cm) x 36" (91 cm)
Assembled weight	155 lbs. (70 kg)
Weight capacity	450 lbs. (204 kg)
Casters	Four (2 locking)
Warranty	2 years for electrical and mechanical components; lifetime for the bed frame

Item No.	Description
MDR107003E	Full Electric Bed
MDR107002E	Semi-Electric Bed
MDSBEDCART	Bed Cart

Transport your Basic bed with ease. Just fold, attach and roll!

- Makes beds easy to transport and facilitates efficient storage.

Item No.	Description
MDSBEDCART	Transport Cart



New-and-improved remotes with large buttons for exceptional ease of use



Expanded Competitive Bidding Program

PROGRAM TO PURCHASE DURABLE MEDICAL EQUIPMENT

Second Phase



DID YOU KNOW...?

Medline beds are priced to provide you with the best possible value – in terms of longer warranties and valuable technical support.

As of August, 2011, Round One of competitive bidding yielded reductions of 35% compared to the fee schedule, 51% of contracts awarded to small businesses, and no changes in beneficiary health status. Inquiries in the first quarter of 2011 totaled less than 0.9 percent of calls to the Medicare call center, and Medicare received only 45 complaints during that time.

THE EXPANDED ROUND TWO CATEGORIES OF PRODUCTS ARE:

- Oxygen, oxygen equipment, and supplies
- Standard (Power and Manual) wheelchairs, scooters, and related accessories (a new category that combines all mobility devices)
- Enteral nutrients, equipment, and supplies
- Continuous Positive Airway Pressure (CPAP) devices and Respiratory Assist Devices (RADs) and related supplies and accessories
- Hospital beds and related accessories
- Walkers and related accessories
- Negative Pressure Wound Therapy pumps and related supplies and accessories (new category)
- Support surfaces (Group 2 mattresses and overlays)

c MS will now begin a pre-bidding supplier awareness program for Round Two, and conduct a national mail order competition for diabetic testing supplies at the same time as the Round Two competition.

A list of ZIP codes included in Round Two and a list of the specific items in each product category are available on the website for the Competitive Bidding Implementation Contractor: www.dmecompetitivebid.com

Additional information on the competitive bidding program is available at: http://www.cms.hhs.gov/DMEPOSCompetitiveBid/01_overview.asp#TopOfPage

1. Medicare to Save Taxpayers And Beneficiaries \$28 Billion With an Expanded Competitive Bidding Program. Centers for Medicare and Medicaid Services. <http://www.cms.gov/apps/media/press/release.asp?Counter=4064&intNumPerPage=10&checkDate=&checkKey=2&srchType=2&numDays=0&srchOpt=0&srchData=competitive+bidding&keywordType=All&chkNewsType=1%2C+2%2C+3%2C+4%2C+5&intPage=&showAll=1&pYea.> Accessed 10/5/2011.



Bariatric Beds

Safety and security
for a good nights rest



Three powerful AC motors raise the head section, foot section and overall height with ultra-quiet and smooth operation.

Above shown with Bariatric bed MDR107004, mattress MDR211892, side rail MDS89697BAR, and overbed table MDS104015.

Bariatric Beds are:

Strong

- Comfortably accommodates larger patients with a 600 lb. (272 kg) weight capacity and an extra-wide deck: 42" (107 cm) x 80" (203 cm)
- Reinforced pan deck creates a strong bedding surface

Easy

- Split-frame design sets up with minimal tools and simplifies delivery
- Smooth rolling casters allow easy positioning of bed

Reliable

- Strong AC motors provide reliable lifting for years
- Durable remote features easy-to-access buttons

Bariatric Full-Electric Bed

Split-spring design provides for easy setup with minimal tools and trouble-free delivery.



- ▶ Split-frame design provides for easy setup with minimal tools and trouble-free delivery
- ▶ Mattress not included
- ▶ Three AC motors for the head section, foot section, and overall height

Specifications

Weight capacity	600 lbs. (272 kg)
Extra-wide pan deck	42" (107 cm) x 80" (203 cm)
Assembled weight	320 lbs. (145 kg)
Height range	18" - 26.5" (46 cm - 67 cm)
Casters	Four (2 locking)
Warranty	2 years for electrical and mechanical components; lifetime for the bed frame

Item No.	Description
MDR107004	Bariatric Full-Electric Bed

Premium Full-Electric Bariatric Beds

Two available widths in one easy-to-operate bed. Slide feature adjusts the bed width from 38"-48" (97-122 cm), allowing the bed to be used as a gurney for easy transfer through doorways.

- Linak motors allow for dynamic movement without disturbing a partner or surrounding residents
- Foot section does not pitch down, but plateaus to reduce edema of lower extremities
- Includes mattress
- Three DC motors for the head section, foot section and overall height
- Optional bed-mounted trapeze, 6" (15 cm) extended length to 86" (218 cm), heavy-duty side rails and digital scale

Specifications

Weight capacity	750 lbs. (340 kg)
Height range	15"-28" (38-71 cm)
Casters	Four locking casters
Warranty	1 year for electrical and mechanical components; 5 years for the bed frame



BHAQP3848
Mattress included.
Bed rails sold separately.

Item No.	Description
BHAQP3880	38"W (97 cm) Full-Electric Bariatric Bed
BHAQP4880	48"W (122 cm) Full-Electric Bariatric Bed
BHAQP5480	54"W (137 cm) Full-Electric Bariatric Bed
BHAQP6080	60"W (152 cm) Full-Electric Bariatric Bed
BHAQP3848	Adjustable-Width Bariatric Bed
BHARA01920	Bed Rails
BHARA01920EX	Bed Rails for Low-Air Loss Mattress
BHATRQP48	Trapeze for Full-Electric Bariatric Beds

Premium Low-Height Full-Electric Bariatric Beds

Low height helps minimize the possibility of injuries for patients who pose a risk of falling out of the bed.

- Linak motors allow for dynamic movement without disturbing a partner or surrounding residents
- Foot section does not pitch down, but plateaus to reduce edema of lower extremities
- Includes mattress
- Three DC motors for the head section, foot section and overall height
- Optional bed-mounted trapeze, 6" (15 cm) extended length to 86" (218 cm), heavy-duty side rails and digital scale

Specifications

Weight capacity	750 lbs. (340 kg)
Casters	Four locking casters
Height range	9"-24" (23-61 cm)
Warranty	1 year for electrical and mechanical components; 5 years for the bed frame



Mattress included.
Bed rails sold separately

Item No.	Description
BHALB3848	Low-Height, Full-Electric Bariatric Bed, Adjustable Width, 38"-48" x 80" (97-122 cm x 203 cm)
BHARA01920	Bed Rails
BHARA01920EX	Bed Rails for Low-Air Loss Mattress
BHATRQP48	Trapeze for Full-Electric Bariatric Beds
BHASC1000	Scale for Low-Height Full-Electric Bariatric Bed

Premium Extra Weight Capacity Full-Electric Bariatric Bed

Ultra-strong beds with a full 1,000 lb. (454 kg) wt. capacity

- Linak motors allow for dynamic movement without disturbing a partner or surrounding residents
- Includes mattress
- Foot section does not pitch down, but plateaus to reduce edema of lower extremities
- Multiple positions (Trendelenberg, Reverse Trendelenberg and Cardio Chair)
- Independent head and knee gatch for personalized positioning



Mattress included.
Bed rails sold separately

Specifications

Weight capacity	1,000 lbs. (454 kg)
Height range	15.25"-24.5" (39-62 cm)
Casters	Four locking casters
Warranty	1 year for electrical and mechanical components; 5 years for the bed frame

Item No.	Description
BHAKP48801	Three Quarter, 48"W (122 cm), Extra Weight Capacity Full Electric Bariatric Bed
BHAKP54801	Full, 54"W (137 cm), Extra Weight Capacity Full Electric Bariatric Bed
BHAKP60801	Queen, 60"W (152 cm), Extra Weight Capacity Full Electric Bariatric Bed
BHAKP384801	Adjustable Width, 38" x 80" (97 x 203 cm) converts to 48" x 80" (122 x 203 cm) Extra Weight Capacity Full Electric Bariatric Bed
BHATRP1000	Trapeze for Extra Weight Capacity Full Electric Bariatric Bed
BHARA01920	Bed Rails
BHARA01920EX	Bed Rails for Low-Air Loss Mattress
BHASC1000	Scale for Extra Weight Capacity Full Electric Bariatric Bed



SALES TIP

Add on a sale with a Bath Safety or Walking Aids product. Take the opportunity to help customers match up their bathing or transferring needs.



Accessories



Medline carries all the mattresses and home care bed accessories you need to deliver the utmost in quality and comfort and to assist safety.

Above shown with bed MDR107002E, mattress MDR237827E, side rail MDS89690, trapeze bar MDS80615T and overbed table MDS107015

MedLite and Basic Bed Accessories

Low Bed Conversion Kit

Convert your Full-Electric MedLite bed into a MedLite Low bed!

- Easy installation – no tools needed!

Item No.	Description
MDSLOWBED	MedLite Low Bed Conversion Kit



4" (10 cm) Bed Extension Kit

Increases bed length from 80" to 84" (203 to 213 cm)

- Easy assembly – no tools needed!
- Retains 450 lb (204 kg) capacity

Item No.	Description
MDR630EXTN	4" (10 cm) Bed Extension Kit



Transport Cart

Makes beds easy to transport and facilitates efficient storage

Item No.	Description
MDSBEDCART	Transport Cart



Mattresses

A healthy step toward a good nights sleep

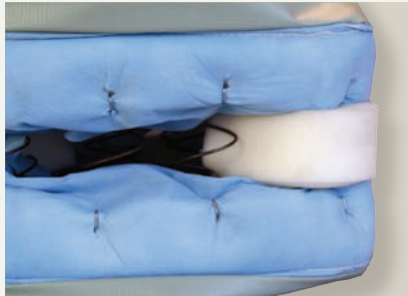

Durable 8-oz. vinyl mattresses feature antimicrobial ticking

- Inverted side seams for patient comfort and caretaker convenience
- Your choice of innersprings, standard foam or high performance fiber

Innerspring

Item No.	W x L x H: Inch (cm)	Weight Capacity
MDR237827	36 x 80 x 7 (91 x 203 x 18)	250 lbs. (113 kg)
MDR230982	35 x 80 x 8 (89 x 203 x 20)	400 lbs. (181 kg)

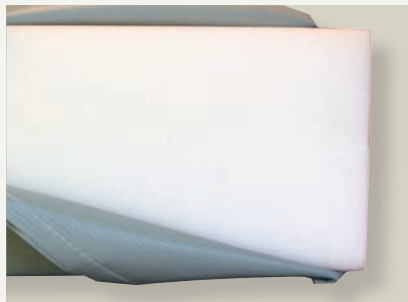

Standard Foam

Item No.	W x L x H: Inch (cm)	Weight Capacity
MDR230981	36 x 80 x 6 (91 x 203 x 15)	350 lbs. (159 kg)
MDR211892	42 x 80 x 6 (107 x 203 x 15)	600 lbs. (272 kg)



High Performance Fiber

Item No.	W x L x H: Inch (cm)	Weight Capacity
MDR237827E	36 x 80 x 6 (91 x 203 x 15)	350 lbs. (159 kg)

Side Rails

Safety and security allows rest, without worry

Standard

Tool-free installation!

- Attractive hammertone finish hides fingerprints and complements home décor
- Spacing between bars is less than 4" (10 cm) for patient safety
- MDS89694 and MDS89690 adjust in length from 48" to 72" (122 to 183 cm)
- MDS89694N and MDS89697 meet FDA Entrapment Guideline



Item No.	Description
MDS89697	Half Rail, Small Gap Clamp-on

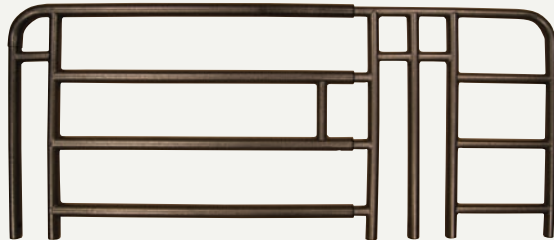

Item No.	Description
MDS89694N	Full Side Rail, 4 Bar Telescoping



Item No.	Description
MDS89690	Full Side Rail, 3 Bar Telescoping

Bariatric

Easy installation with minimal tools.

- Pull knob to adjust height of the rail
- Rail mounts to the pan deck under the mattress for a safe and solid mount
- Rail is easily and quickly removable with a pull of the button

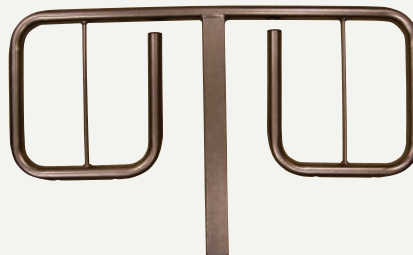

Item No.	Description
MDS89697BAR	Half Rail, Bolt-On

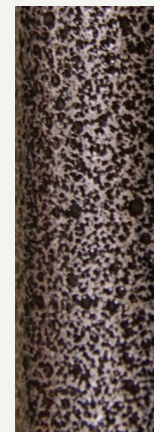

Hammertone Finish on all Side Rails



Trapeze Bars

Giving a hand in changing or transferring positions

Standard

Frame is constructed of heavy-gauge, chrome plated, steel tubing for maximum strength. Wall bumpers and padded mounting brackets protect bed ends and wall surfaces.

- Assembles without tools
- Optional base allows trapeze to be free standing
- Assisted weight capacity: 250 lbs. (113 kg)

Item No.	Description
MDS80615T	Trapeze Bar
MDS80616T	Trapeze Base (Optional)

Mounts to bed or optional base.



Bariatric

Frame is constructed of heavy-gauge, steel tubing for maximum strength.

- Four-piece sub-assembly significantly reduces set-up time
- Tool-free design simplifies assembly
- Assisted weight capacity: 1,000 lbs. (454 kg)

Item No.	Description
MDS1000TPZ	Bariatric Trapeze Bar





Composite-Top

Unlike wood tables, this table will not crack or peel. It's easy to keep clean and impervious to moisture.

- 30" x 15" (76 x 38 cm) molded composite top
- One-hand adjustable from 30" to 47" (76 to 119 cm)
- Durable, chrome base
- Holds up to 50 lbs. (23 kg)

Item No.	Description
MDS107015	Composite-Top, Overbed Table



Overbed Tables

Ideal for reading, eating, writing...

Laminate Top

Automatic spring lift mechanism adjusts height from 28" to 45" (71 to 114 cm).

- 30" x 15" (76 x 38 cm) top with walnut wood grain melamine laminate with a T-mold edge
- Chrome-plated column and base
- Holds up to 50 lbs. (23 kg)

Item No.	Description
MDS104015	Walnut Laminate Overbed Table



Laminate Tilt-Top

Separate tilt and raise/lower handles allow for safe and independent operation of table functions. Raised edge holds books and papers in place.

- 30" x 15" (76 x 38 cm) top with walnut wood grain melamine laminate with a "T" mold edge
- Three-position tilt with squeeze of the handle
- Height adjustable from 28" to 45" (71 to 114 cm)
- Holds up to 50 lbs. (23 kg)

Item No.	Description
MDS104950	Walnut Laminate Overbed Table

Lifts

Battery-Powered Total Floor Lift

Attractive white finish.

- 6 point cradle
- FREE washable sling*

Item No.	Weight Capacity
MDS400EL	400 lb (181 kg)

*Choose one washable sling from page 23. Specify size with corresponding item number. (Must order separately)

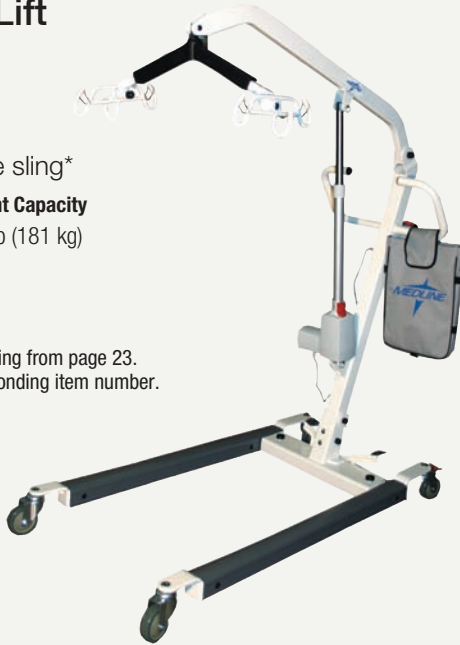

Hydraulic Lift

Strong, reliable and easy to operate.

- 6 point cradle for maximum safety
- Base easily opens with hand lever
- Dimensions: 5.5" (14 cm) base height; 42" (107 cm) length; outside width of base: 26"-31.5" (66-80 cm); inside width of base: 22"-33.5" (56-85 cm)
- Warranty: 3 years for mechanical components

Item No.	Weight Capacity
MDS88200D	400 lb (181 kg)



COMES WITH FREE 6-POINT FULL-BODY SLING!



Stand Assists

Manual Stand Assist

More affordable alternative to battery-powered stand assists.

- Patient grabs onto an assist bar and pulls up using their own strength

Item No.	Weight Capacity
STA182	400 lb (181 kg)



Battery-Powered Stand Assist

Removable foot platform for standing and walking practice.

- Attractive white finish
- FREE washable sling*

Item No.	Weight Capacity
MDS400SA	400 lb (181 kg)



*Choose one washable sling from page 23. Specify size with corresponding item number. (Must order separately)



Slings

U-Shaped Slings – for 6-Point Cradles Only

Easy to put under and remove from patients.

- Washable padded fabric
- Designed for comfort and ease-of-use
- Secure, easy-to-fit general purpose sling



MDSHC70002



MDSHC70012

No Head Support

Item No.	Description
MDSHC70002	Medium, 500 lbs. (227 kg) weight capacity Best fit 99-210 lbs, (45-95 kg)
MDSHC70001	Large, 500 lbs. (227 kg) weight capacity Best fit 198-350 lbs, (89-159 kg)
MDSHC70000	X-Large, 600 lbs. (272 kg) weight capacity Best fit 270-600 lbs, (122-272 kg)

With Head Support

Item No.	Description
MDSHC70012	Medium, 500 lb. (227 kg) weight capacity Best fit 99-210 lbs, (45-95 kg)
MDSHC70011	Large, 500 lb. (227 kg) weight capacity Best fit 198-350 lbs, (89-159 kg)
MDSHC70010	X-Large, 600 lbs. (272 kg) weight capacity Best fit 270-600 lbs)

Full-Body Slings – for 4-Point or 6-Point Cradles

Designed for comfort and safety.

- Washable padded fabric
- Four-point hookup
- Fewer loops to connect to the cradle



MDSR113



MDSR115

Solid-Fabric Full-Body Slings

Item No.	Description
MDSR112	Medium, 450 lb. (204 kg) weight cap.
MDSR113	Large, 450 lb. (204 kg) weight cap.
MDSR117	X-Large, 450 lb. (204 kg) weight cap.

Mesh Full-Body Slings

Item No.	Description
MDSR110	Medium, 450 lb. (204 kg) weight cap.
MDSR111	Large, 450 lb. (204 kg) weight cap.
MDSR140	XX-Large 600 lb. (272 kg) weight cap.

Mesh Full-Body Slings with Commode Opening

Item No.	Description
MDSR114	Medium, 450 lb. (204 kg) weight cap.
MDSR115	Large, 450 lb. (204 kg) weight cap.
MDSR116	X-Large, 450 lb. (204 kg) weight cap.
MDSR141	XX-Large, 600 lb. (272 kg) weight cap.

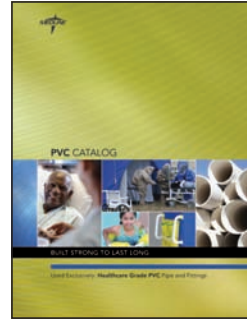
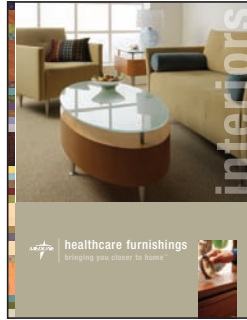
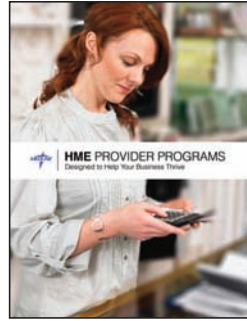
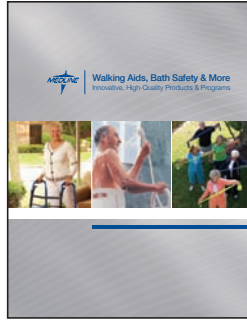

GET ALL THE DETAILS

Contact your Medline sales representative for one of our other great catalogs.

VISIT US AT MEDLINE.COM:

- 1 Download a QR Code reader app
- 2 Launch app
- 3 Scan this QR Code



Medline Industries, Inc.

One Medline Place
Mundelein, IL 60060

Medline United States
1-800-Med Line (633-5463)

www.medline.com | info@medline.com

Medline Canada
1-800-396-6996

www.medline.ca | canada@medline.com

Medline México
01-800-831-0898

www.medlinemexico.com | mexico@medline.com

Some products may not be available for sale in Mexico or Canada. We reserve the right to correct any errors that may occur within this brochure.
©2011 Medline Industries, Inc. Medline is a registered trademark of Medline Industries, Inc. Linak is a registered trademark of Linak A/S Corporation.

MKT211337 / LIT158 / 10M / VP / 10